

# BW DVR - M/TOWER

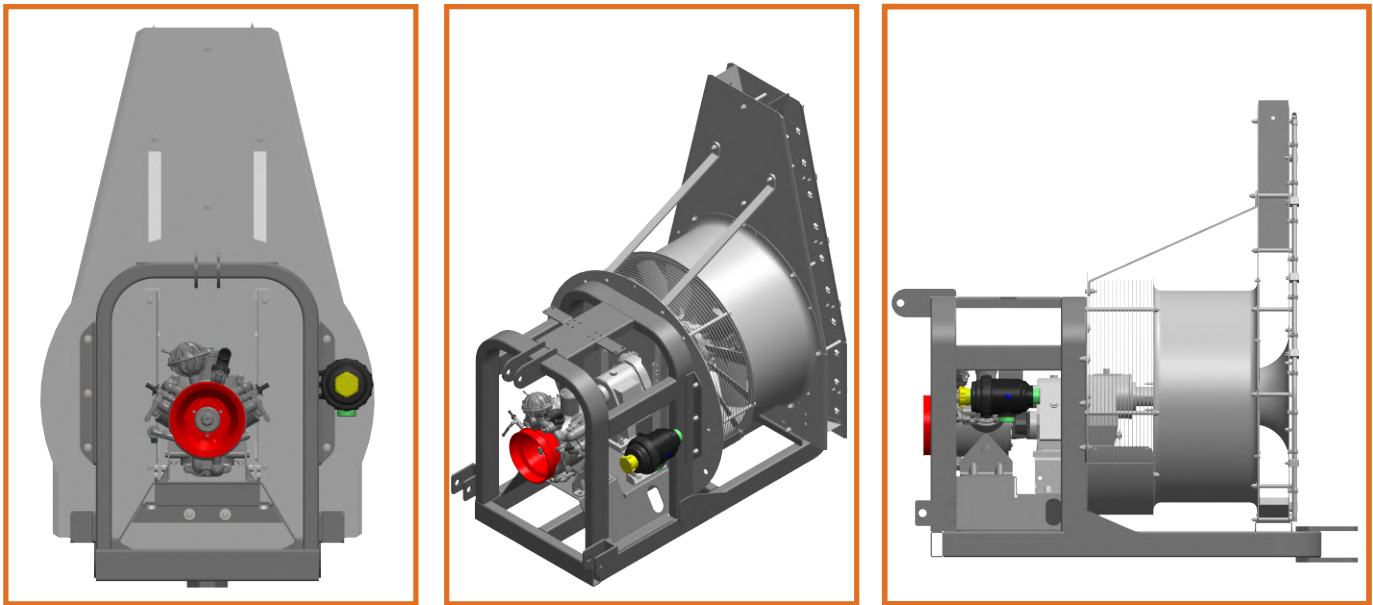





Mounted opposite counter - rotating fan for trailed tank



🇬🇧 The mounted fan BW-PN DVR - M/TOWER is a model provided with two rotating propellers and opposite suction system, specialized in particular for the spraying of espallier intensive orchards. Thanks to its ventilation system you can obtain a spraying uniformity equal to 100% on both sides, as it has high performance and low power absorption, more over, the new generation spraying nozzles with a low environmental impact allow to regulate perfectly the consumption of the nozzles from minimum 200 lt/ha to maximum 900lt/ha, working at low operating pressures and achieving a perfect spraying result and high efficiency

## STANDARD EQUIPMENT

- Air fan with two counterrotating nylon fans, at double speed. In model Ø800 mm fans are equipped with clutch linings
- Nozzle - Holder arches in stainless steel with n.22 Brass anti-drip triple nozzles with cannon K75, ALBUZ 60° ORANGE, Standard Nozzle 1,5
- Hot Galvanized Reinforced Chassis
- Electric Remote Command Unit ARAG model GR881 from tractor with pressure regulator ECC
- Stainless Steel Counter-Rotating Fan Unit (Ø800 DVR M-TOWER) with adjustable upper and lower deflector
- ANNOVI REVERBERI brass pump model BHS 130
- Connection pipes kit to the trailed Tank
- Back Trailer Hitch with connection plug to the hook the sprayer, exhaust valves for the whole system to drain the water from the circuit
- Machine is supplied with drive shaft model T50/900
- In-line brass filter model M146

MODELLO MODEL MODÈLE						M <sup>3</sup> /Hr	 Modello Model Modèle	L/Min	
BW - DVR 800 M/TOWER	800 mm	9+9	22	2	6,0 - 8,0 mt	45000 - 55000 m <sup>3</sup> /hr	BHS130	130 L/Min	80/90 hp

— Ø800 M/TOWER —